



DEXO

Glass partitions GS II.



# Design with Precision, Crafted to Perfection

A timeless interior is achieved through a combination of a personal approach and precise execution. The GS II. glazed partitions blend elegance, functionality, and outstanding acoustic performance. Thanks to double glazing, they provide excellent sound insulation, ensuring a calm and comfortable environment.

We offer both straight and curved variants, each providing a refined and distinctive look. Both options can be produced with visible or hidden profiles. For lovers of the industrial style, the Grid variant with vertical mullions is available.

We design and manufacture sustainable and functional glazed partitions and glazed doors made of glass, aluminium, or wood, always fully aligned with valid ETA (European Technical Assessment) standards. You don't need to have a complete vision – that's exactly why we're here. We help you design the project and perfect it down to the smallest detail. We bring to life spaces that are a joy to work or live in.

We enjoy unconventional and ambitious projects in which we combine our long-standing construction experience, creativity, and strong sense of design. We follow – and help shape – the latest trends in both technology and materials so that we can provide you with modern solutions that work today and stand the test of time.



We work with Saint-Gobain Glass carrying the Cradle to Cradle Certified® certification.

ORAÉ® glass features a 42% reduced carbon footprint and contains up to 64% recycled glass.



Fully in accordance with the Environmental Product Declaration (EPD®).

# Curved Walls

The timeless design of the curved GS II. glazed walls, combined with high acoustic insulation and sound-absorbing elements, creates a user-friendly environment where aesthetics meet functionality.

This results in an ideal space for focused, calm work – a place where both lawyers and their clients can feel comfortable and undisturbed.



Glazed wall:  $R_w = 47-52$  dB  
Door:  $R_w = 40-42$  dB



Purian Kubic



Purian Design



Purian Tech



# A Symbol of Modern Architecture

If anyone understands beauty, it is Notino. Across all twelve floors of their new headquarters, we installed curved acoustic partitions and elegant Purian Design sound-insulating doors that shape the character of the entire space.

You will also find Purian eMove sliding doors, integrated information displays, our mobile sliding wall system, and quiet call boxes. Each floor features its own distinct colour scheme, and every detail has its purpose. The design of the project won the main award in the Office of the Year competition.



Glazed wall:  $R_w = 47 \text{ dB}$   
Doors:  $R_w = 40 \text{ dB}$



# Double Glazing & Wood

The frameless elegance, functionality, and calm atmosphere define the GS II. Design glazed partitions. When paired with veneered doors, acoustic wooden wall panels, and interior curtains, they create a warm and inviting space where you will enjoy spending your time.



Glazed wall:  $R_w = 43-52$  dB

Doors:  $R_w = 32-43$  dB



Wooden



Purian Kubic



Urban Plus



# Glass Doors & Clear Views

The clean, straight lines of the Design walls create a modern and refined appearance. You may choose versions with visible or hidden profiles. High-pile carpets, acoustic wall panels, or moss walls significantly enhance the acoustic comfort of the workspace. Practical call boxes provide a quiet place for undisturbed phone calls or meetings.



Glazed wall:  $R_w = 47-52$  dB  
Doors:  $R_w = 40-42$  dB



Purian Kubic



Purian Design



Urban Plus



# Stylish Decals & Smart Office Solutions

Double-glazed partitions can be enhanced with electronic privacy film, integrated blinds, or graphic decals. Control elements for lighting, access readers, information displays, or electrical sockets can be incorporated directly into installation panels and door frames.

For a higher level of acoustic comfort, we offer the option of installing ceiling or wall acoustic panels, as well as acoustic curtains, ensuring privacy and an undisturbed working environment.

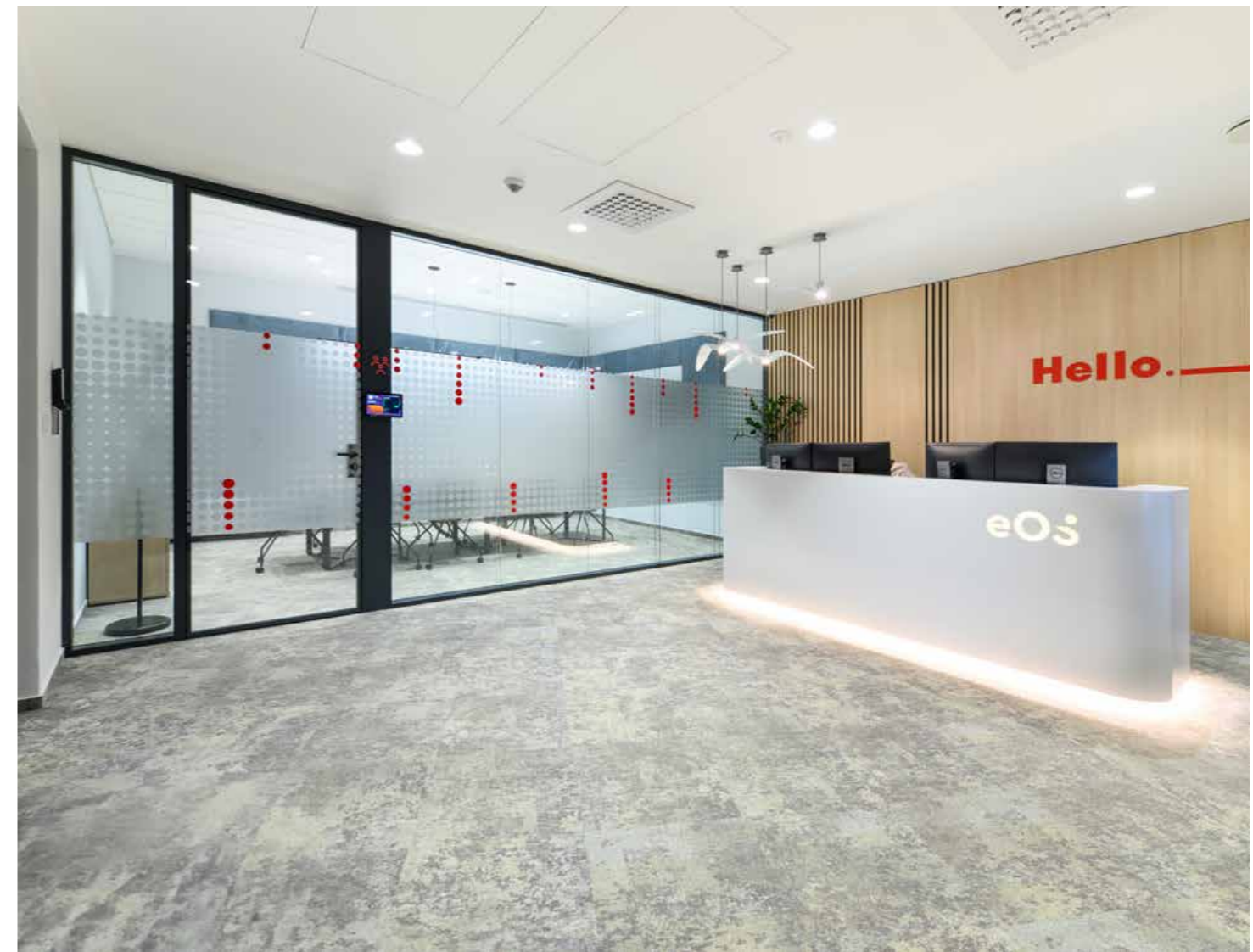



## Elegance Within the Glass

We present unique office interiors featuring internal vertical mullions in the Slim design. The elegant 4 mm thin mullion immediately draws attention. You can choose the colour finish according to your vision – for example a wood décor, a striking black, or any other option that complements the overall interior concept.

The acoustic glazed panels provide outstanding sound insulation of up to 51 dB, ensuring that the new offices are not only stylish and inviting, but also excellently soundproofed.



Glazed wall:  $R_w = 48, 51 \text{ dB}$   
 Doors:  $R_w = 32-42 \text{ dB}$



Wooden



Purian Design



Urban Plus



# Industrial Look

The GS II. Grid double-glazed partitions, with their distinctive grid appearance, combine modern industrial design with first-class acoustic performance. The walls can be divided both horizontally and vertically to suit the spatial layout and overall aesthetic concept.

For even higher acoustic comfort, you can choose the GS II. Aku variant, an extra sound-insulating version with acoustic profiles and an  $R_w$  value of up to 56 dB.



Glazed wall:  $R_w = 45-56$  dB  
Doors:  $R_w = 32-43$  dB



Urban Plus



Wooden



# Fire-Resistant Walls and Doors

The Flamo glazed partition system achieves fire resistance ratings from EI 15 to EI 60, depending on the type of glass used, while maintaining a high level of sound insulation (Rw). You can choose between a minimalist frameless option or an architecturally expressive framed design.

We offer both single-glazed and double-glazed variants, with each type fully compliant with current fire safety standards.



# Privatglass

An efficient way to ensure privacy is the use of variable-transparency glazed technology. With a single click, the glass switches to a shaded mode that protects against views from outside, visual distractions, and even sunlight. The dimmable wall uses an intelligent liquid crystal film embedded between two foil layers.

Control options: mobile app, remote control, wall switch.

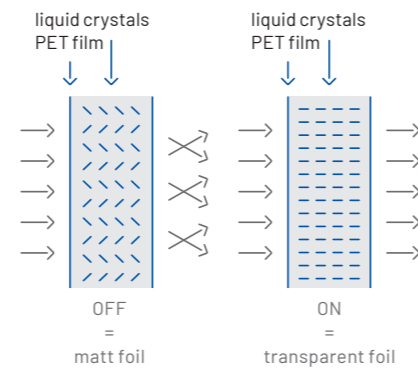

Privatglass	Light Transmission
Standard - classic	89 %
Premium - inverse	91 %



# Titanium Coating Lumoo

Part of our fully glazed partition systems, the Lumoo titanium coating delivers an elegant mirror-like effect without disrupting natural light or the openness of the space. It visually enlarges the room and adds depth.

The special layer transitions smoothly from a reflective appearance to full transparency, creating a natural visual flow between individual zones while enhancing the colour tone and overall atmosphere of the interior.



## Types of Walls



GS II. Design

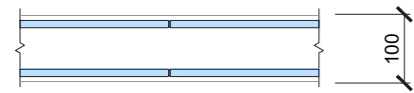

GS II. Grid

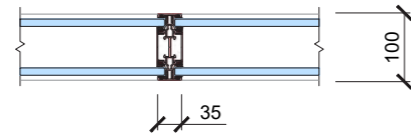

GS II. Slim

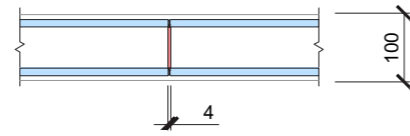

## Types of Doors

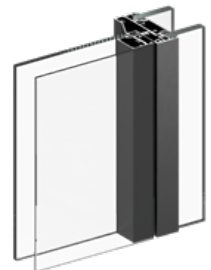

Purian



Framed glazing with double glass



Framed glazing with single glass



Wooden



Frameless

## Horizontal Door Sections

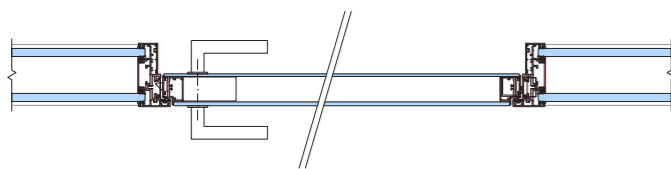

Purian  
Rw = 40-42 dB

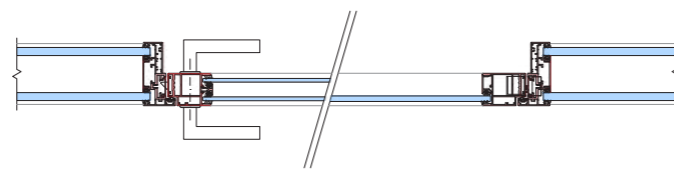

Framed Glazed Type UP  
Rw = 35-43 dB

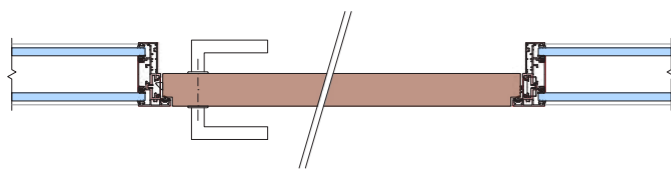

Wooden  
Rw = 32-40 dB

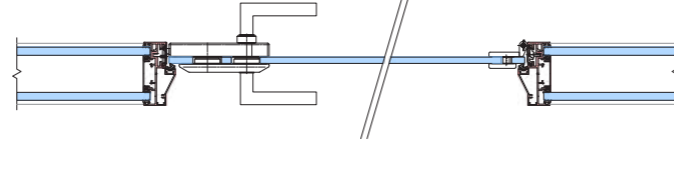

Frameless  
Rw = 33 dB



	GS II. standard	GS II. Aku	GS Flamo
--	-----------------	------------	----------

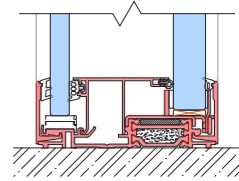
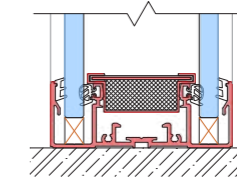
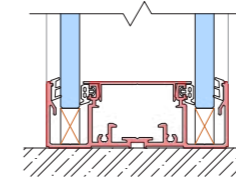

	Design	Grid	Slim	Aku	Flamo
--	--------	------	------	-----	-------

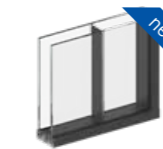

Height (mm)	3400*	4000	3400*	4000	4000*	
Modular Width (mm)	800-1200	800-1200 (≤ 3000)**	800-1000	800-1200 (≤ 3000)**	≤ 1200	
Sound Insulation Rw	41 to 52 dB	45 to 55 dB	48, 51 dB	50, 53, 56 dB	47 to 53 dB	52 to 55 dB
Fire Resistance	-				EI 30 / EI 60	EI 30
Types of Glazing	ESG 10, 12, VSG 55.x, 66.x, 88.x				Pyrobel 16 VSG 66.x	
Approval ETA	ETA					
Application	Office buildings, mixed-use buildings, schools, healthcare facilities...					

\* based on the type of glazing used

\*\* applicable in case of horizontal division

### Requirements for sound insulation between rooms in buildings

Administrative and office buildings	Required wall rating R' <sub>w</sub> (dB)
Offices and workspaces with standard administrative activity, corridors	37 dB
Offices and workspaces with higher requirements, managerial offices	45 dB
Offices and workspaces for confidential meetings	50 dB
Schools and educational institutions	Required wall rating R' <sub>w</sub> (dB)
Classrooms, teaching spaces	47 dB
Common areas, corridors, stairways	47 dB
Noisy areas (workshops, dining halls)	52 dB

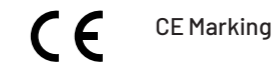

CE Marking

All DEXO GS glazed wall systems have been tested by the Building Research Institute in accordance with the standards ETAG 003 / EAD 210005-00-0505. Based on the European Technical Assessment (ETA), they meet the requirements for CE marking, confirming their quality and compliance with European regulations.



Acoustic Insulation

DEXO GS partition systems were laboratory-tested by the Building Research Institute according to EN ISO 10140-2. The tests confirmed high sound insulation performance that meets demanding acoustic requirements.



Fire Resistance

The DEXO GS Flamo wall system was tested by the Building Research Institute according to EN 1364-1 and achieved fire resistance classifications EI 15, EI 30, and EI 60, depending on the type of glazing used.

## Types of Doors

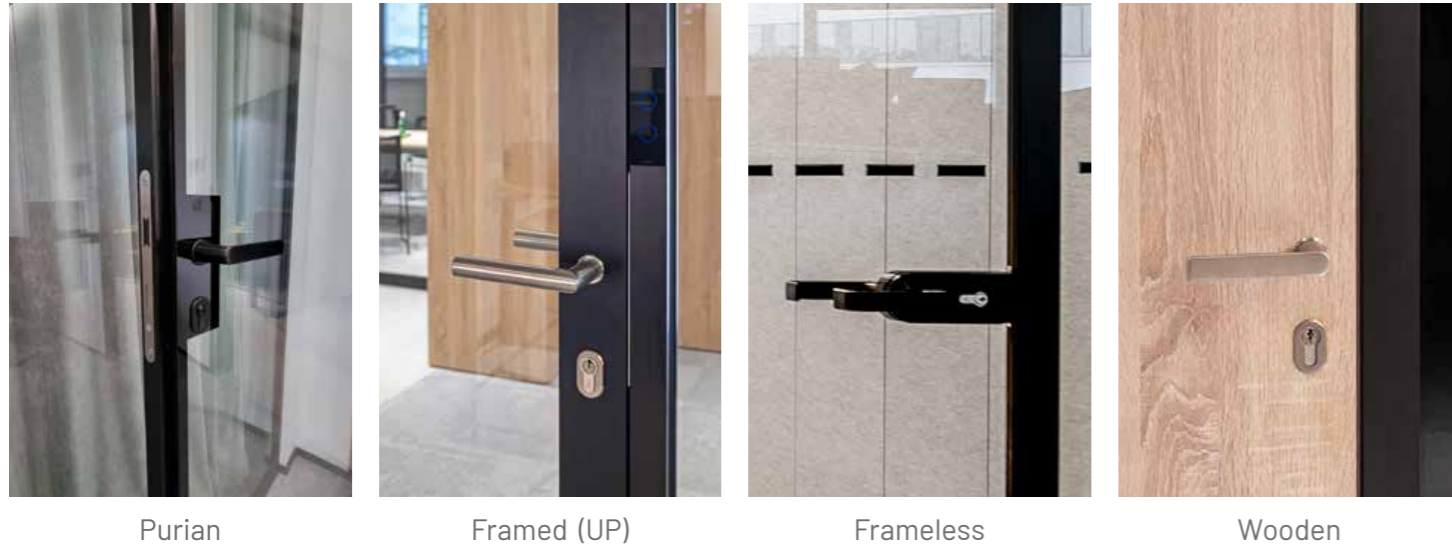

Purian

Framed (UP)

Frameless

Wooden

## DEXO Switches and Readers

Our Smart Office solutions include intelligent switches. Choose the one that suits you and customise the functions to your needs. We offer black and white variants, in both glossy and matte finishes.



DEXO Touch  
touch switch

DEXO Touchless  
contactless switch



Touch  
contactless switch

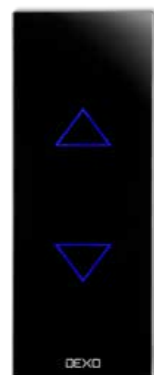

Switch  
switch (suitable for blinds, roller shutters, etc.)



Dimmer  
LED light dimmer



Access  
access via reader

## Axonometry



## Installation panel (IP) at the door:

### Horizontal section

var. 1: IP140 / IP220 design-glass

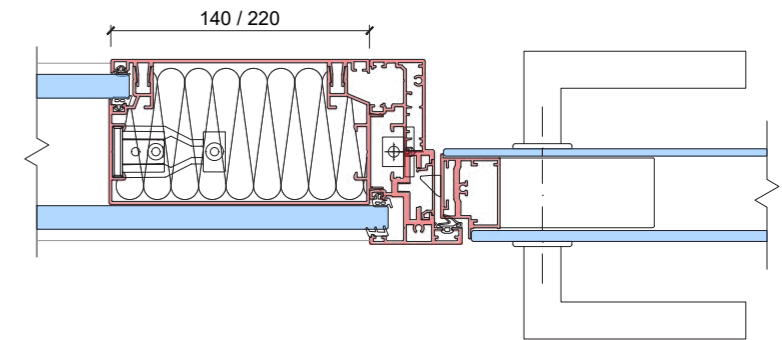

var. 2: IP140 / IP220 design

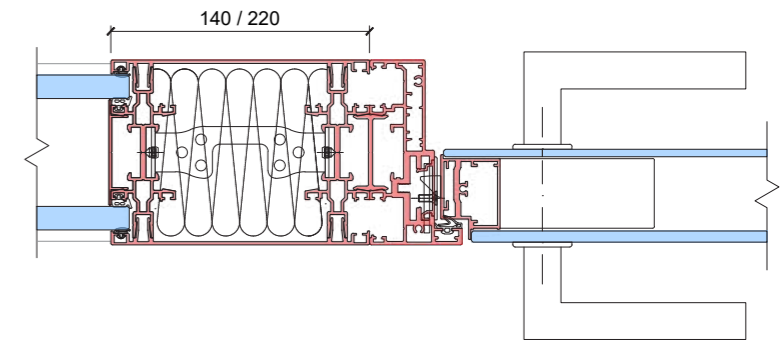

var. 3: IP double-glass

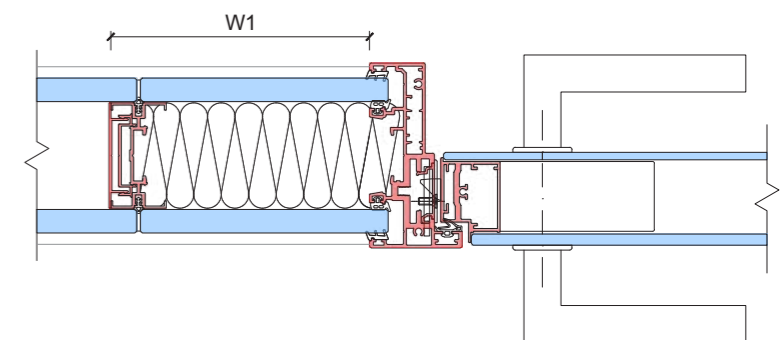

var. 4: IP board

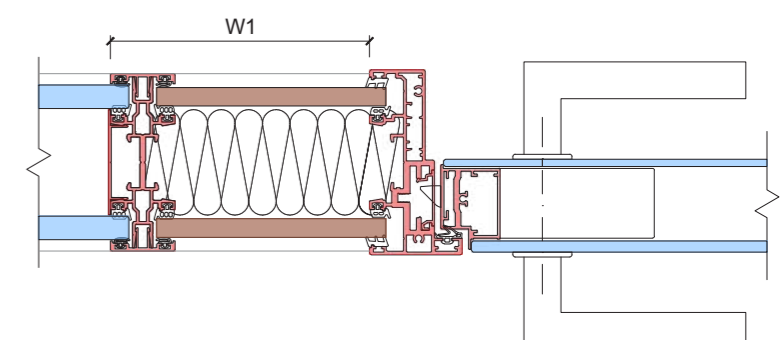

Axonometry



Vertical section

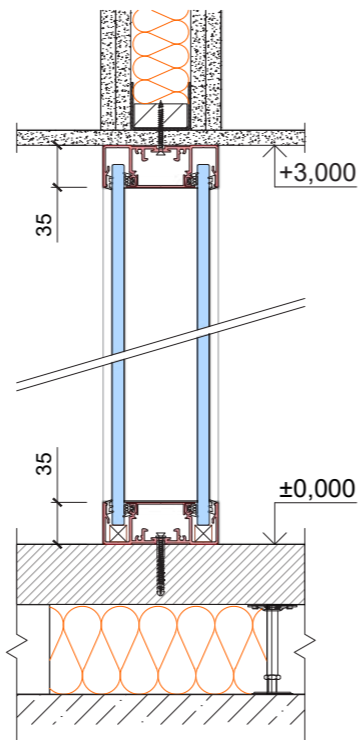

Horizontal section

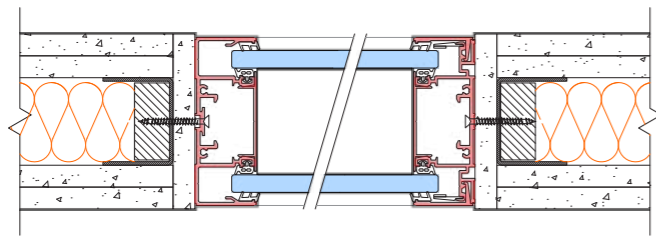

Hidden profile

Axonometry



Vertical section

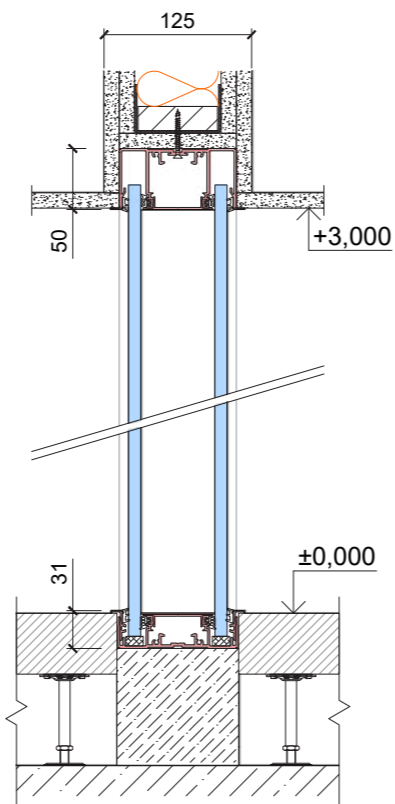

Horizontal section

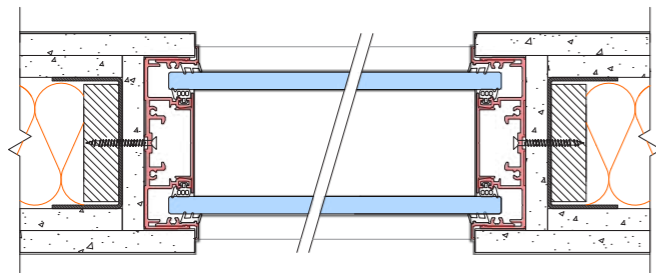

A newly developed glazed sliding door system with a perimeter mini-frame and high sound insulation of  $R_w = 37$  dB – all designed with an emphasis on aesthetics.

Technical specifications:

- door width: 700–1000 mm, height: 2 800 mm
- operated by a double-sided LED button or motion sensor
- exterior and interior motion detector
- backup power supply for emergency opening
- in compliance with the current European standard for escape routes

The system includes a control panel, emergency button, and backup power supply.

Horizontal section

Closed

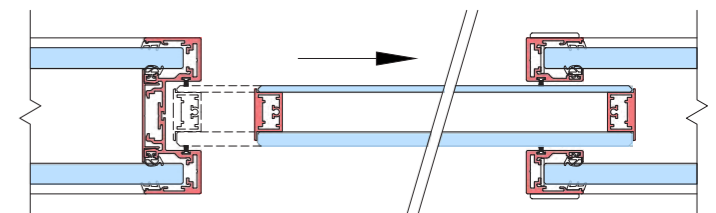

Open



PRAGUE - BRNO - OSTRAVA - BRATISLAVA

[www.dexo.cz/en](http://www.dexo.cz/en)

