



DEXO

Glass partitions GS I.



# New Dimension of Space

Our elegant partitions made of single glass naturally let daylight in and create an airy, open space. They are a great solution for modern office spaces, showrooms and other representative premises.

You may choose a frameless or an industrial framed option. Apart from straight partitions, there is also a curved version, which adds an original and refined look to the room. We offer solutions with visible or hidden profiles, depending on the character and style of the interior.

As part of the DEXO Living range, we create glass staircases and railings, moss walls, glass canopies and glass partitions that can be used as dividing walls or even as part of shower enclosures.

You do not need to have a fully defined vision. That is what we are here for. We help you design the project and perfect it down to the smallest detail. We create spaces that are a joy to live or work in.

A timeless space is achieved by combining a personal approach with precise execution. The sustainable and functional partitions and doors we design and manufacture, made from glass, aluminium or wood, always comply with valid ETA (European Technical Assessment) standards. We enjoy unconventional and ambitious projects in which we bring together our long-standing construction experience, creativity and a strong sense of design.



We work with Saint-Gobain Glass carrying the Cradle to Cradle Certified® certification.

ORAÉ® glass features a 42% reduced carbon footprint and contains up to 64% recycled glass.



Fully in accordance with the Environmental Product Declaration (EPD®).

# Designer Doors and a Clear View

Luxurious partitions with the elegant glass door Purian create a perfect, uninterrupted sightline with no distracting edges. The glass of the door leaf is mounted in front of the internal concealed frame on both sides. The visible glass surface of the door aligns seamlessly with the glass partition, enhancing the elegance of the modern interior.

Deep red acoustic curtains and absorptive wall panels reduce noise and add a striking aesthetic accent to the space. The combination of these two elements provides first-class acoustic attenuation.



Glazed wall:  $R_w = 33-41$  dB  
Doors:  $R_w = 36-40$  dB



Purian Kubic



Purian Design



Purian Tech

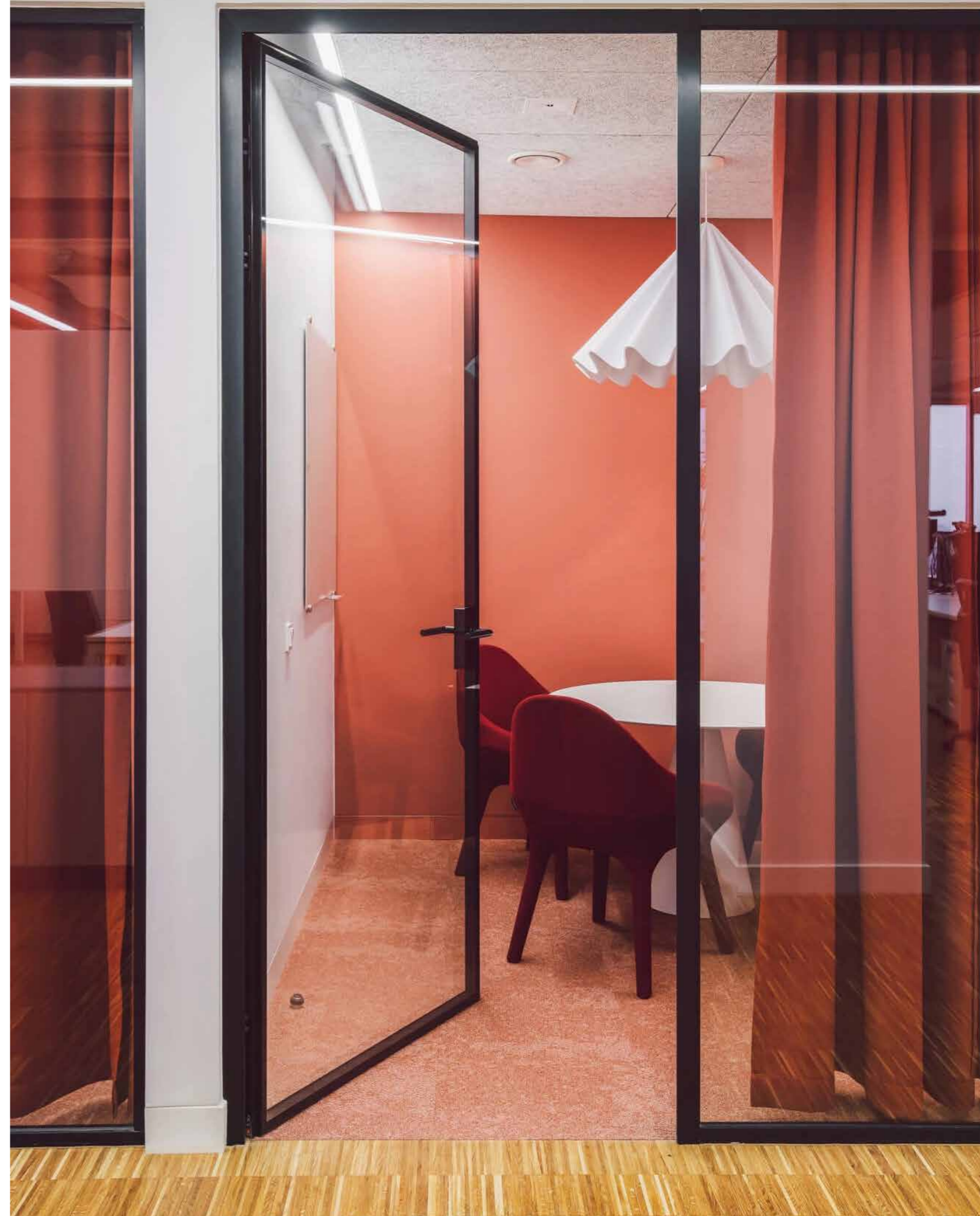

# Beauty in Simplicity

Frameless doors in both single-leaf and double-leaf versions provide perfect harmony of simplicity and clean lines. The combination of clear glass and warm wood panelling on the walls creates a timeless workspace.



Glazed wall:  $R_w = 33-41$  dB  
Doors:  $R_w = 33-40$  dB



Frameless

Lumio Slim

Lumio

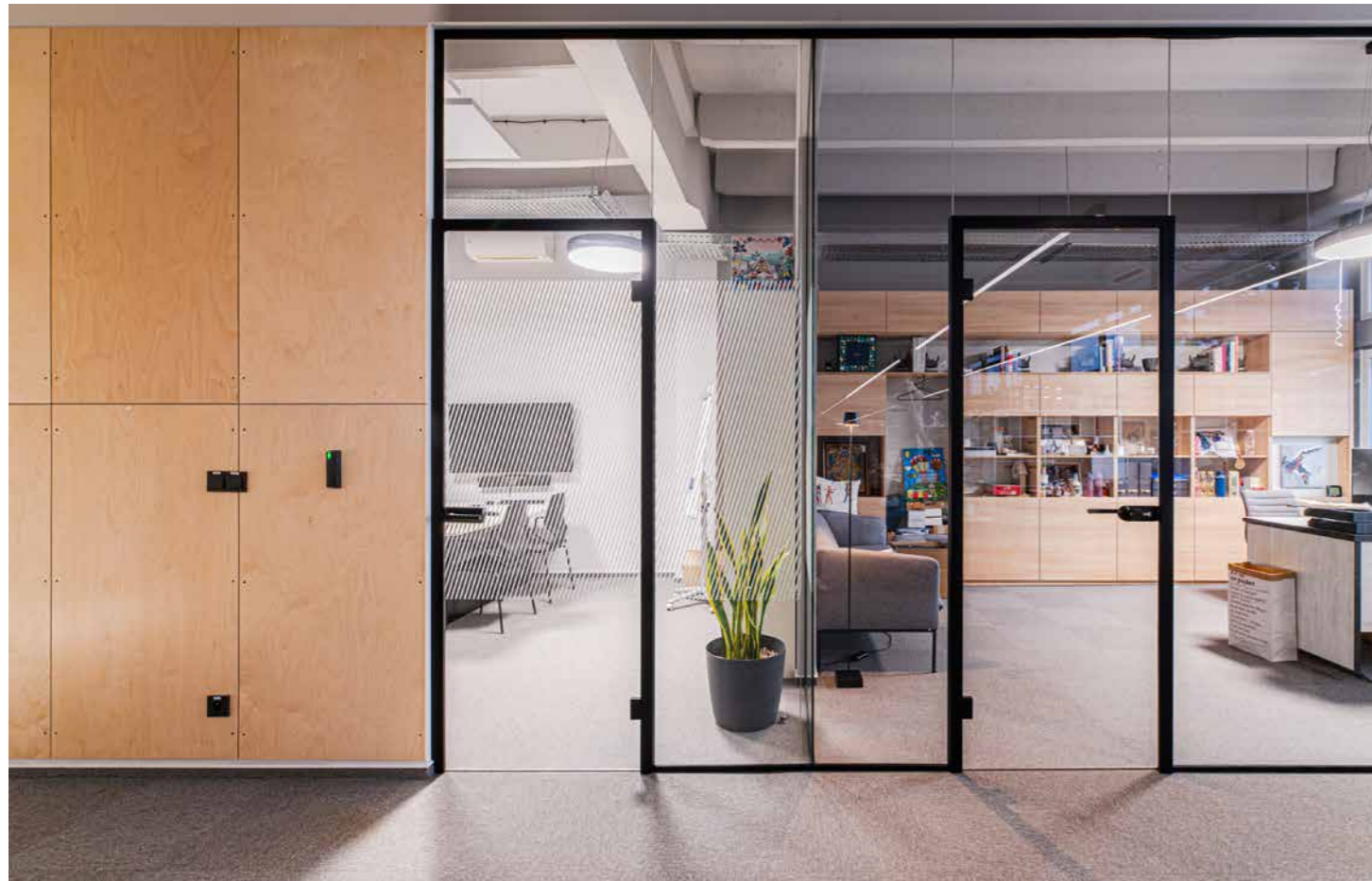

# Curved Walls

The elegant curves of rounded glazed partitions introduce a timeless atmosphere into the interior and allow a maximum flow of light, and emphasise the unique character of the space. We offer solutions with either visible or concealed profiles – choose the option that best suits your interior.



Glazed wall:  $R_w = 33-41$  dB  
Doors:  $R_w = 35-40$  dB



Lumio

Frameless

Purian Design



# The Charm of Wood

GS I. Grid-type partitions with vertical division bring style and modern elegance to the space. The combination with solid wooden doors creates a feeling of warmth and coziness. Integrated information displays serve as a functional element that simplifies communication within the information system and increases the efficiency of shared spaces, especially meeting rooms.



Glazed wall:  $R_w = 36-41$  dB  
Doors:  $R_w = 39-40$  dB



Terra



Purian Kubic



Lumio

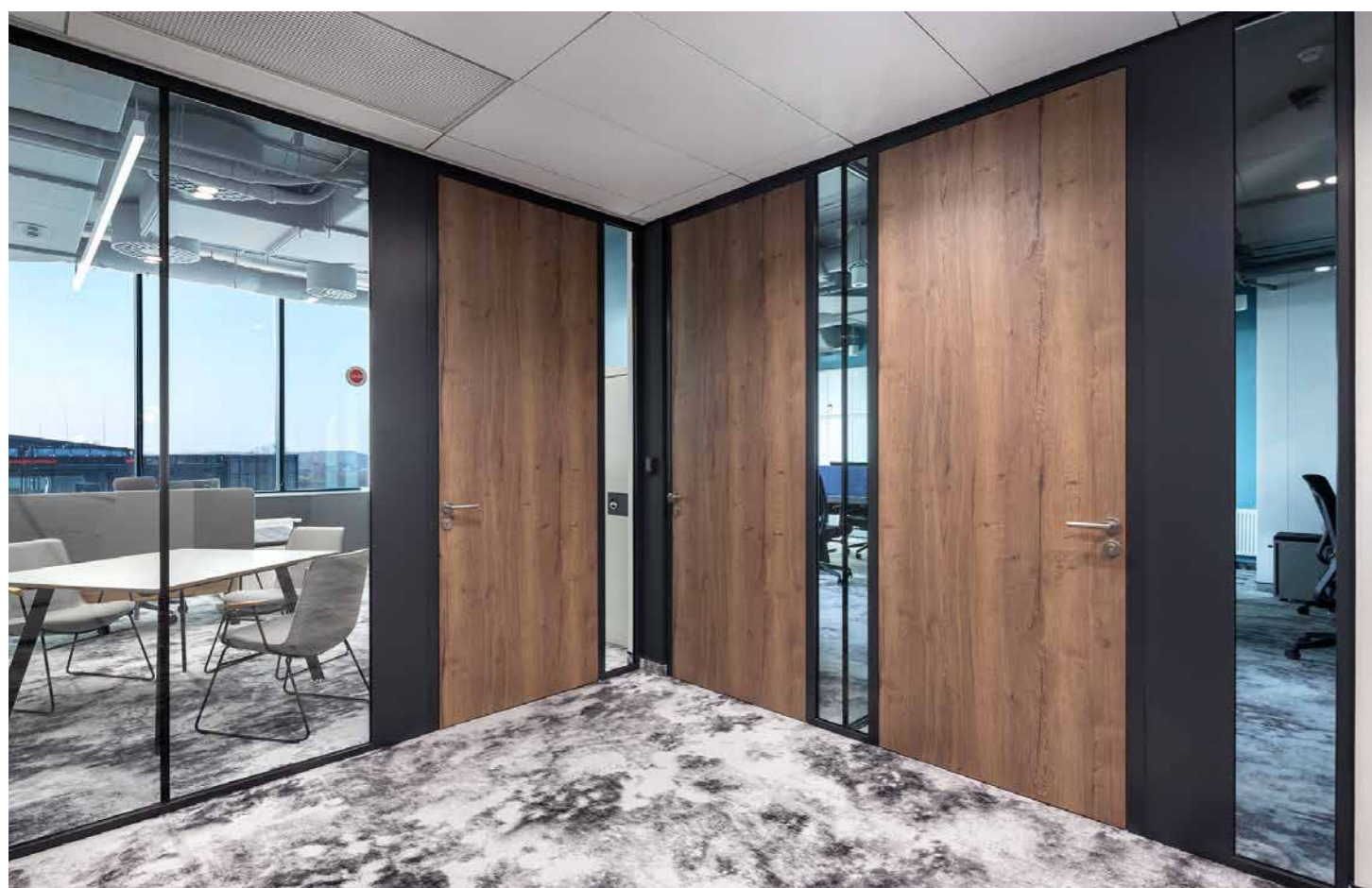

# Harmonious Interior

The industrial character of the GS Grid glass partitions, combined with exposed brick cladding and a slatted wooden ceiling, creates a balanced whole. Acoustic panels on the walls ensure a calm working environment. At the same time, the space provides visual connection while maintaining a high level of acoustic attenuation between the individual rooms.



Glazed wall:  $R_w = 33-41$  dB

Doors:  $R_w = 33-40$  dB



Frameless

Lumio Slim

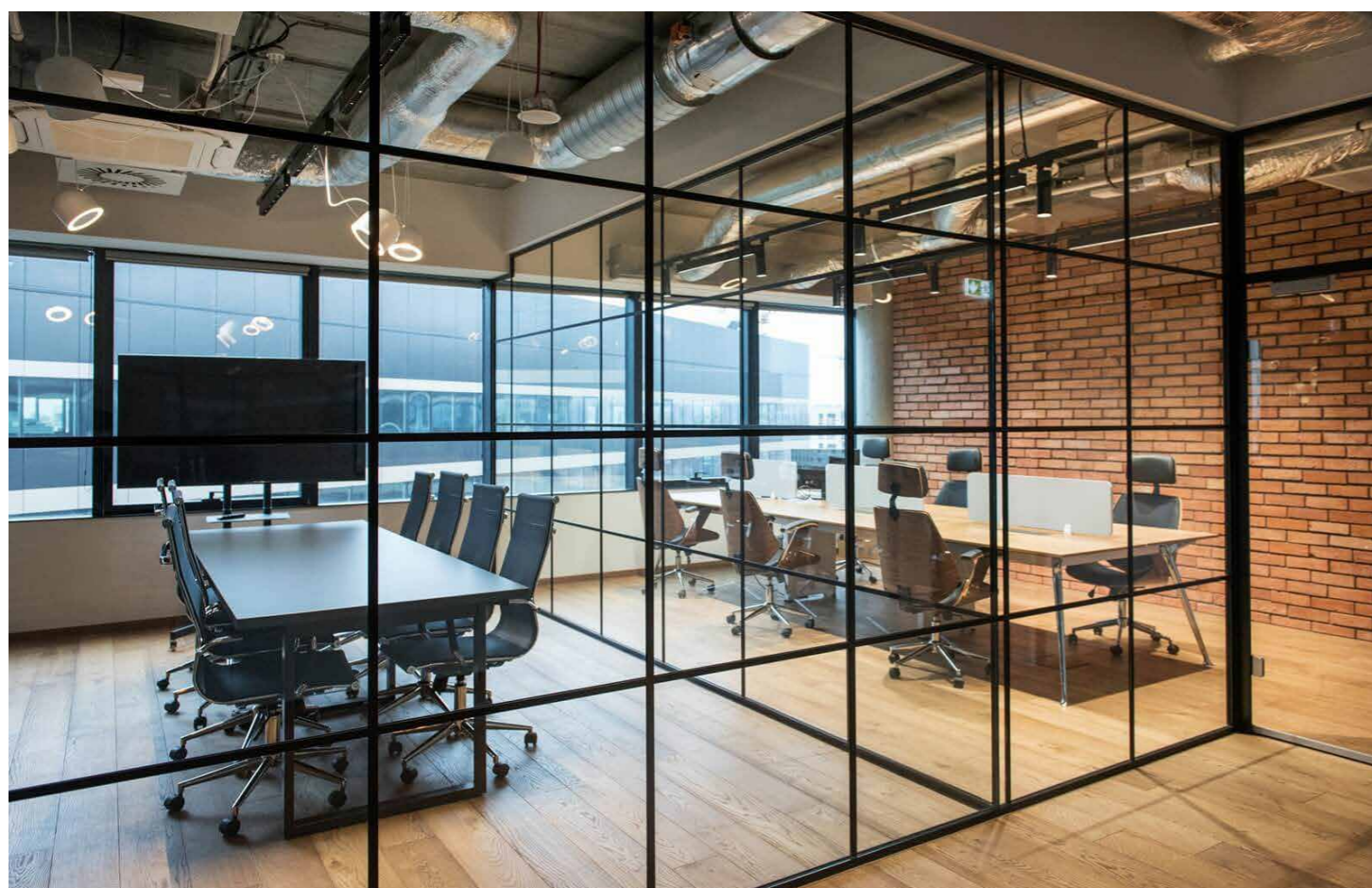

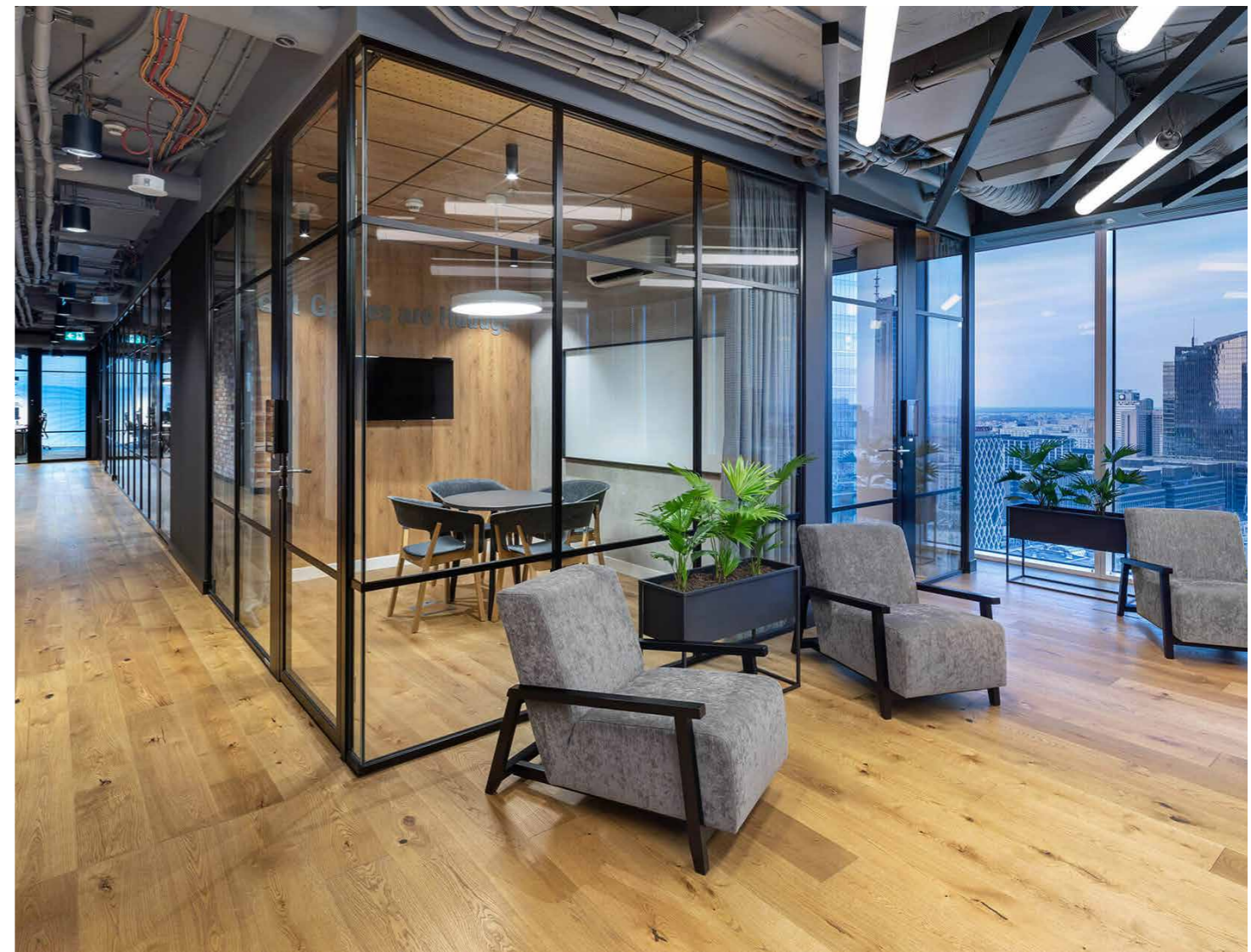

## Industrial Style

The GS Grid walls with grid division create a striking and modern look. The brick cladding highlights the urban character of the interior, while the wooden elements and subtle acoustic panels add a warm visual impression to the space.



Glazed wall:  $R_w = 36-41$  dB  
 Doors:  $R_w = 35-40$  dB

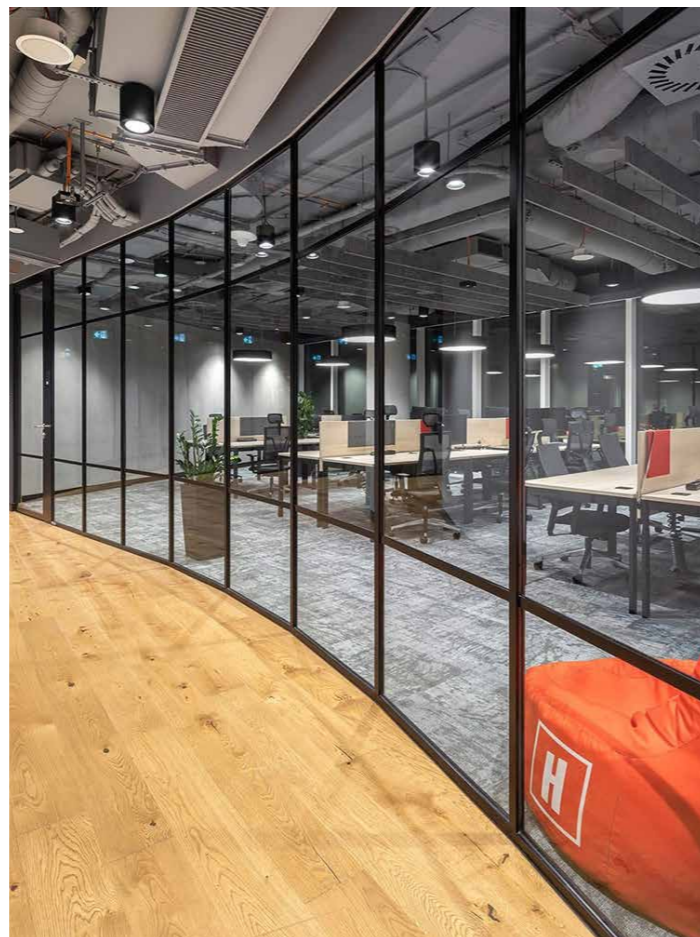

Lumio



Lumio Slim

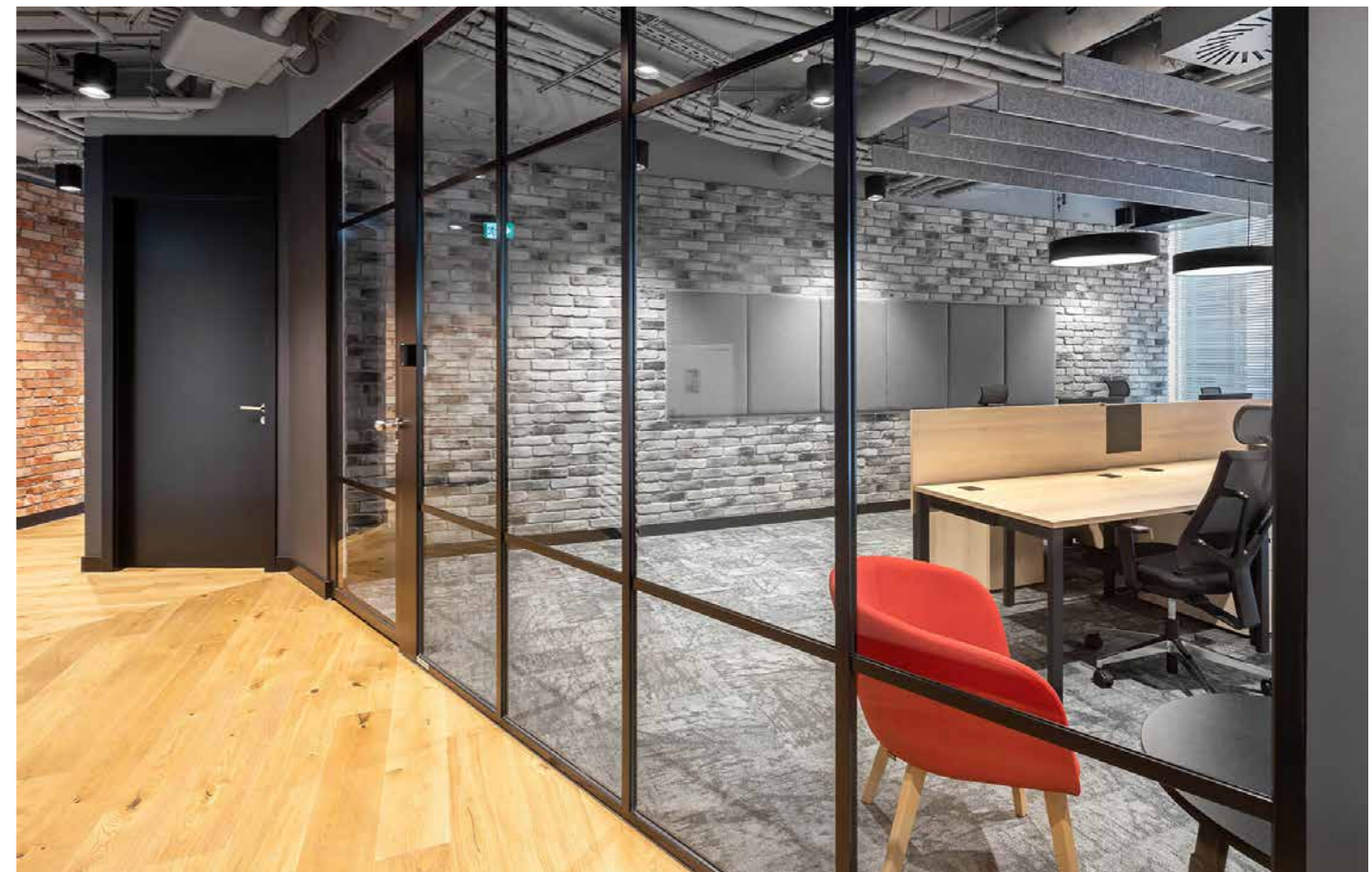

# Stylish Decals & Colourful Acoustic Panels

GS I. Design glazed partitions, in combination with solid wooden doors and striking decals, bring together lightness, simplicity, and functionality. They let in a maximum amount of light and visually lighten the space. They form a bold feature within the harmoniously coordinated interior, complemented by colourful acoustic panels on both the walls and the ceilings.



Glazed wall:  $R_w = 33-41$  dB  
Doors:  $R_w = 33-40$  dB



Terra



Purian Kubic



Lumio



# DEXO Living

We design and install **glazed railings** for both exterior and interior use, **glazed canopies, shower screens,** and **designer glazed partitions** for offices as well as residential spaces.

Connect modern architecture with nature through our **moss walls** made from Scandinavian or Alpine moss. Together, we will choose the ideal colour and texture. Each piece is a custom-made original that creates a bold and refreshing element in your space.

The lightness of glazed surfaces combined with natural accents creates a unique atmosphere at work, in wellness areas, or right in your home.

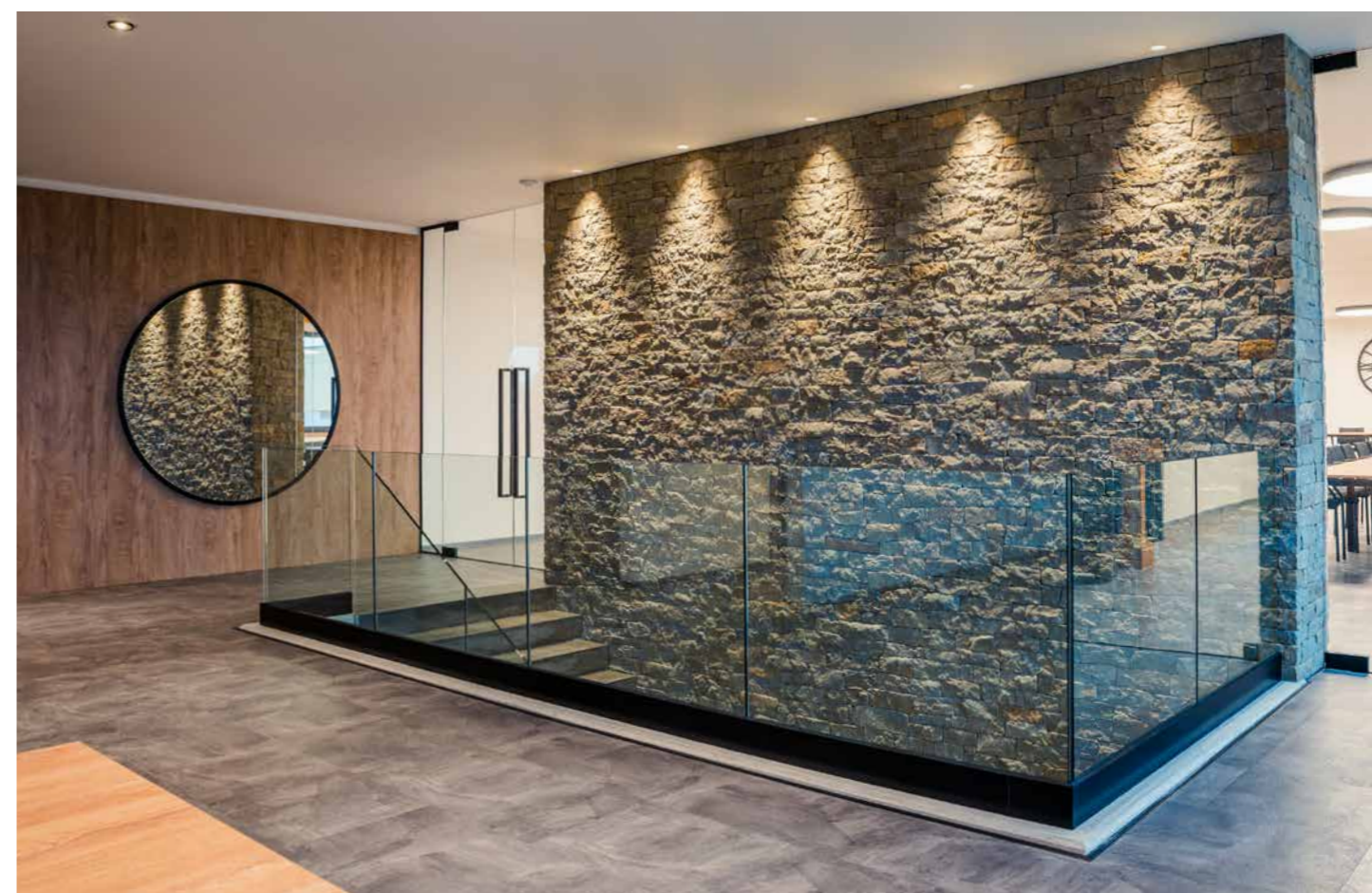
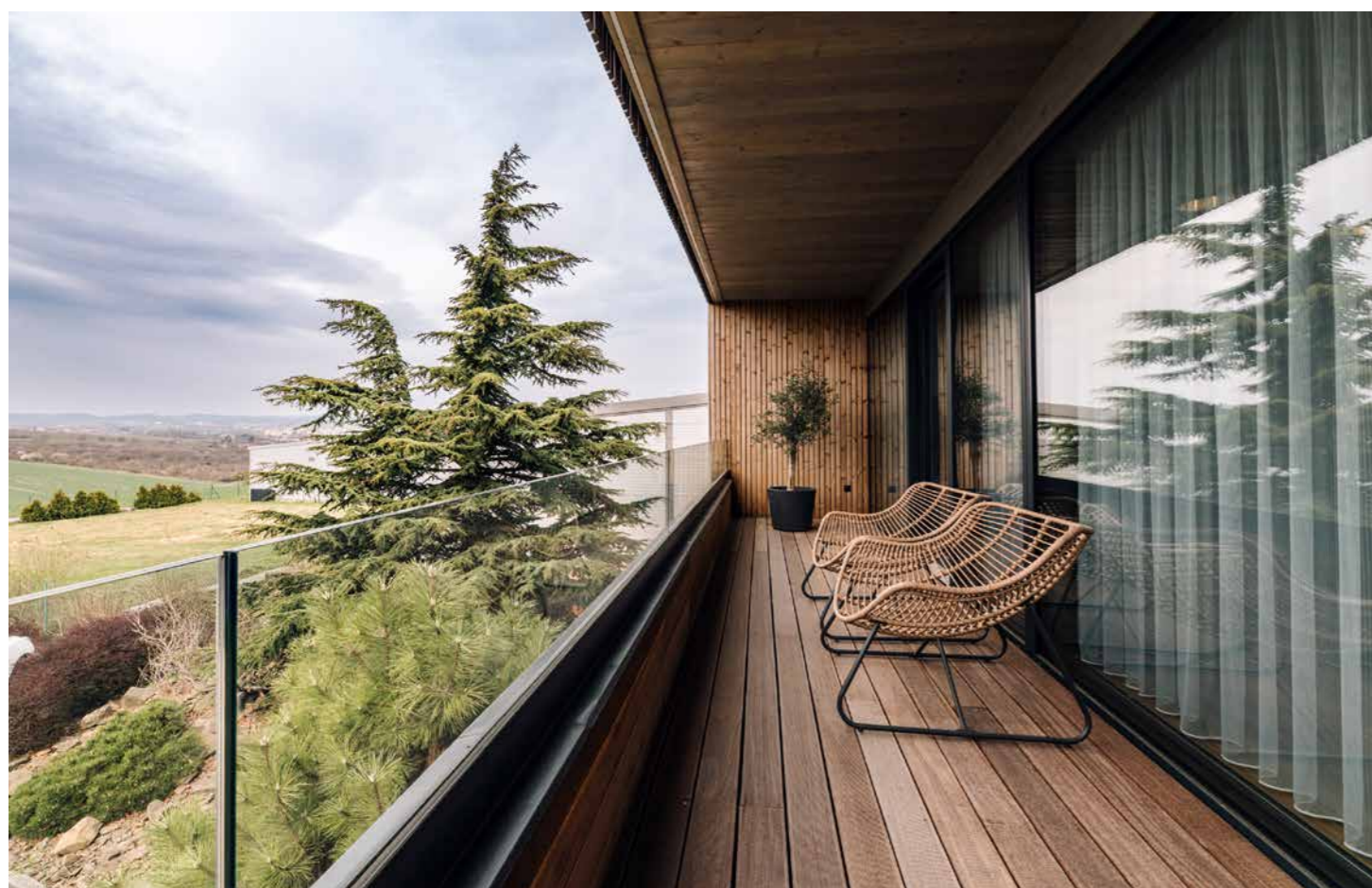
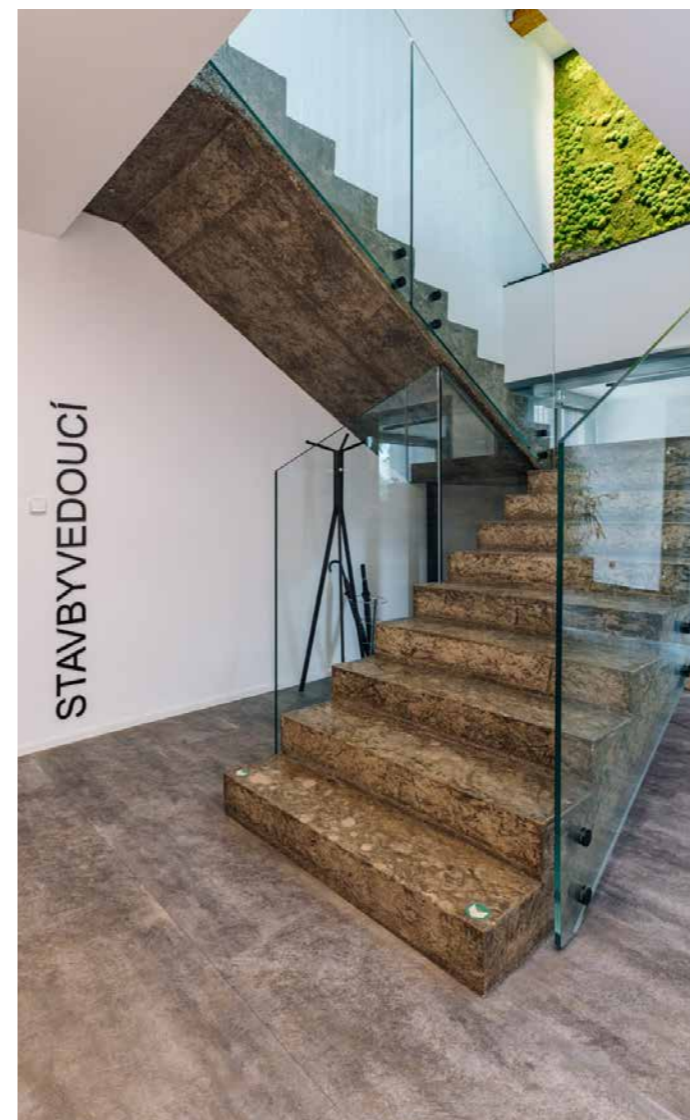

# Residential Living

**Glazed railings** are an elegant, modern, and safe solution for residential living and private interiors. They ensure an unobstructed view while meeting the highest safety standards, whether installed on a terrace or on a staircase inside the house.

Subtle **glazed canopies** above entrances or terraces protect against adverse weather without obstructing the flow of natural light.

**Moss walls** bring the calm of nature into the interior, whether in the bathroom or the living room.

**Frameless glazed doors** combined with a concealed hydraulic hinge provide a timeless yet functional solution for double-sided door opening.

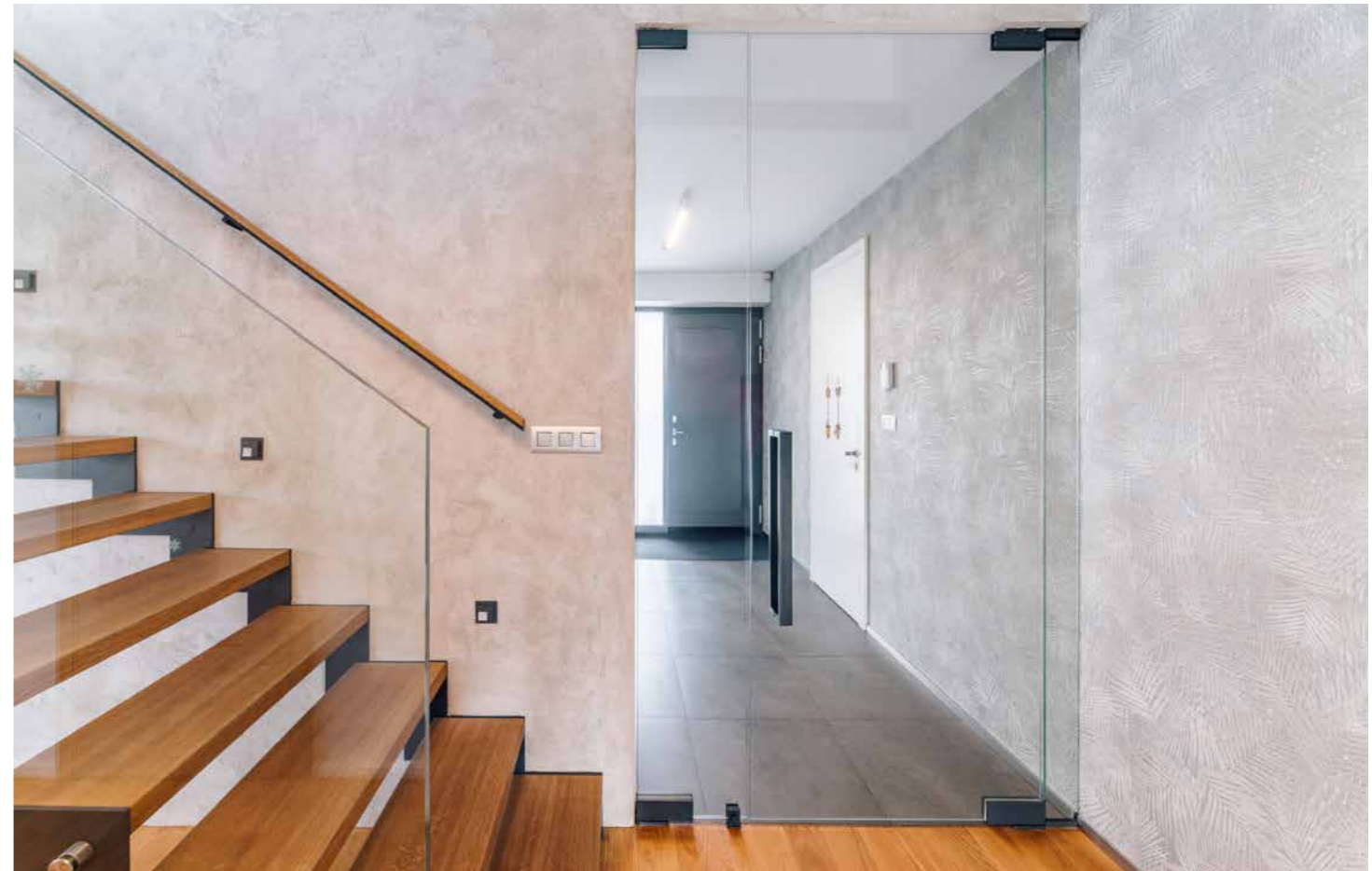
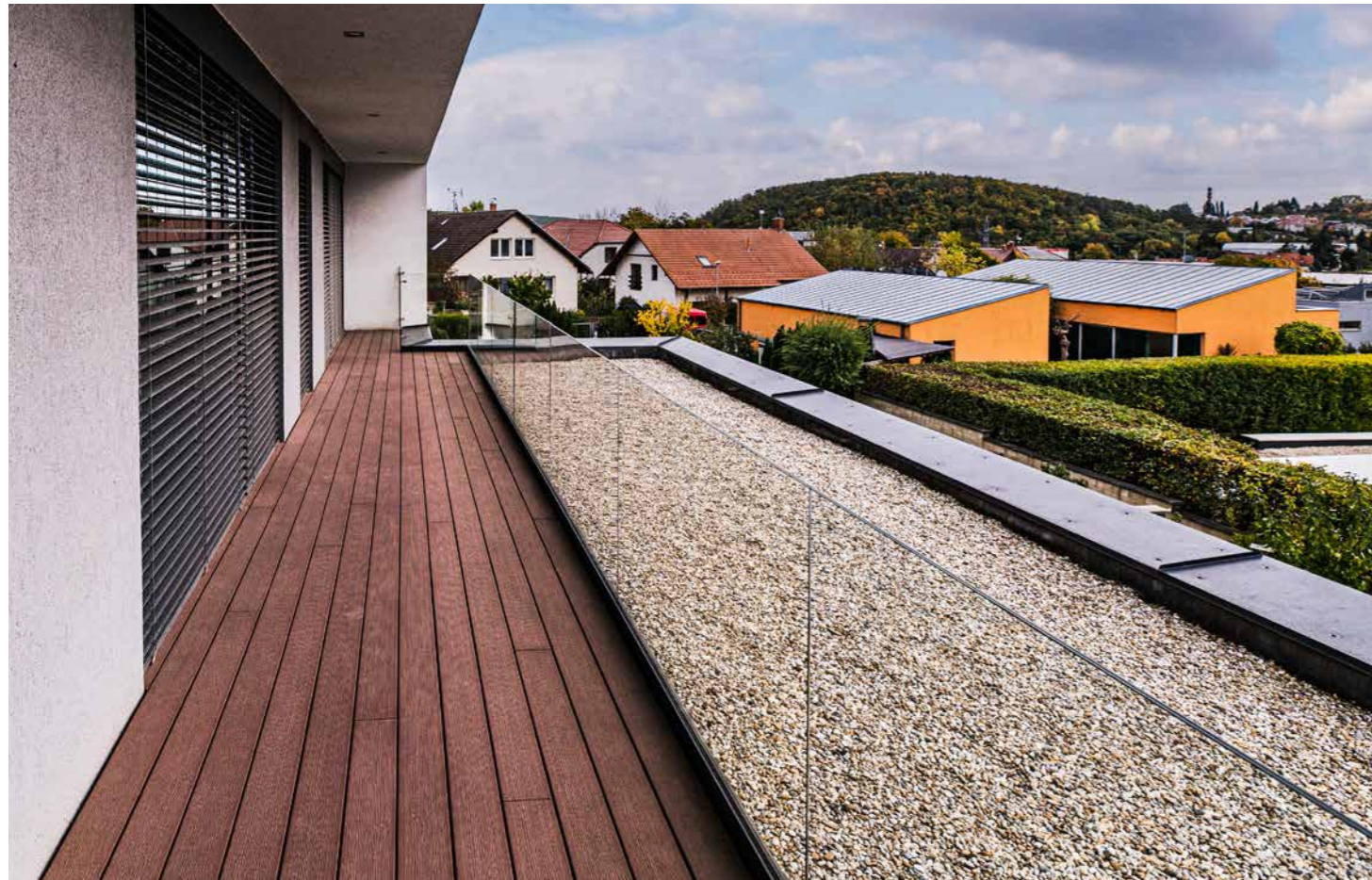

# Privatglass

An efficient way to ensure privacy is the use of variable-transparency glazed technology. With a single click, the glass switches to a shaded mode that protects against views from outside, visual distractions, and even sunlight. The dimmable wall uses an intelligent liquid crystal film embedded between two foil layers.

Control options: mobile app, remote control, wall switch.

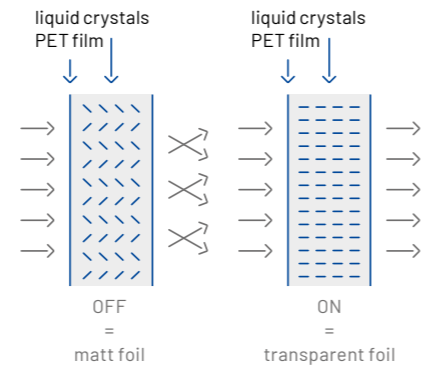

Privatglass	Light Transmission
Standard - classic	89 %
Premium - inverse	91 %



## Hidden profile

Axonometry



Vertical section

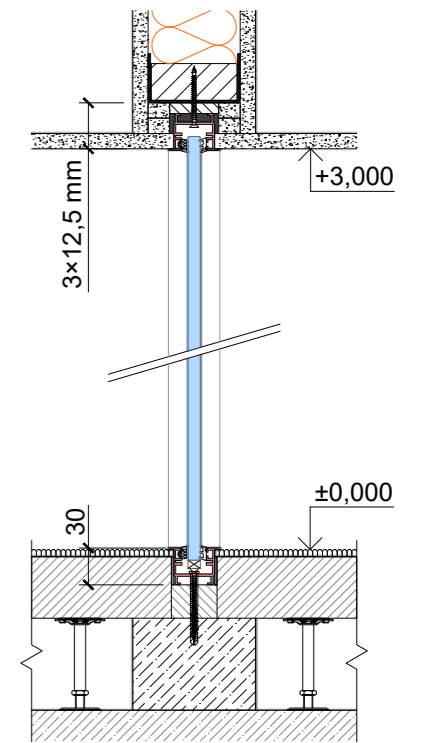

Horizontal section

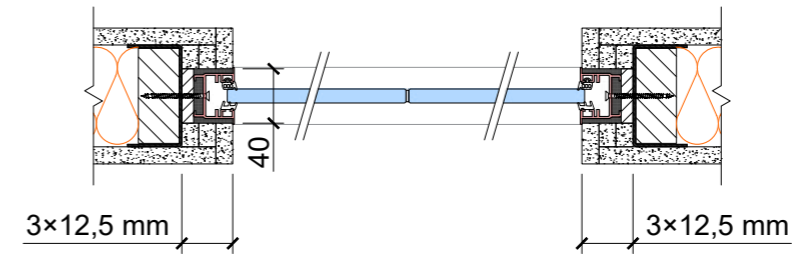

## Visible profile

Axonometry



Vertical section

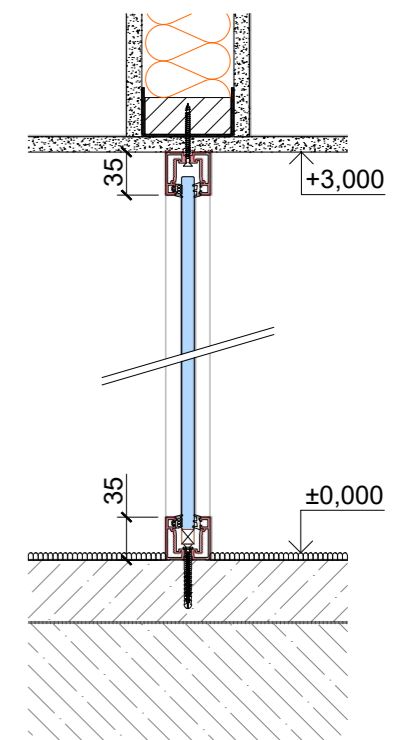

Horizontal section

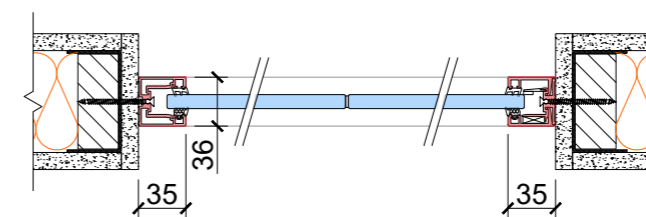

## Types of Doors

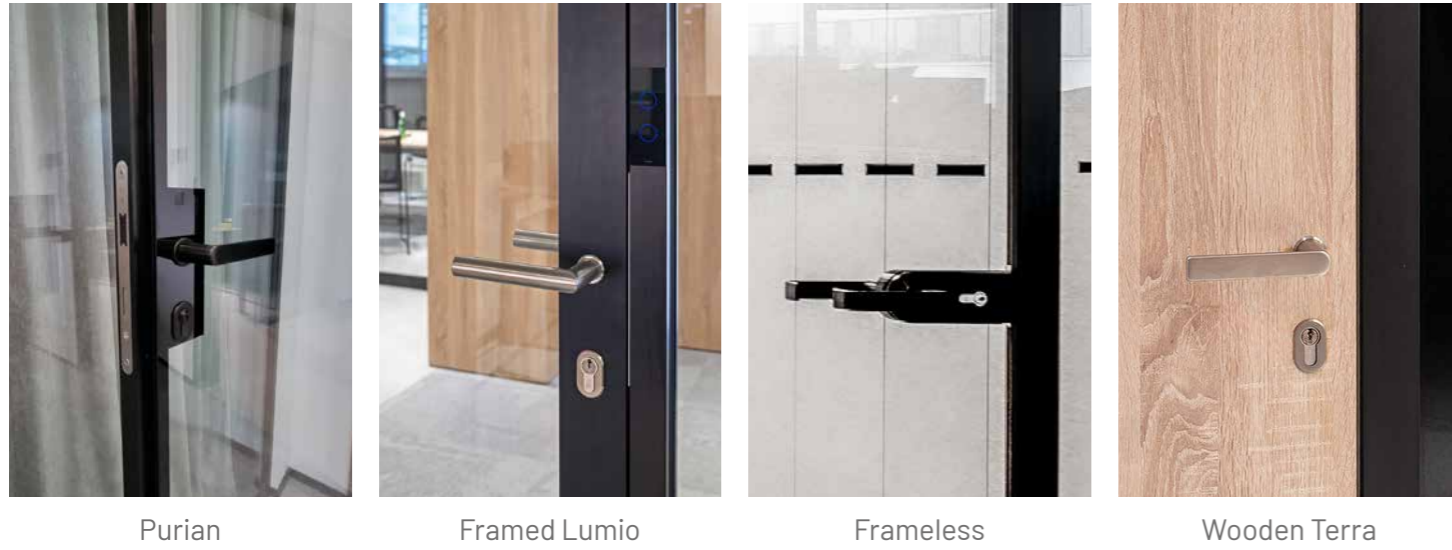

Axonometry



## Installation panel (IP) at the door:

Horizontal section

var. 1: IP double-glass

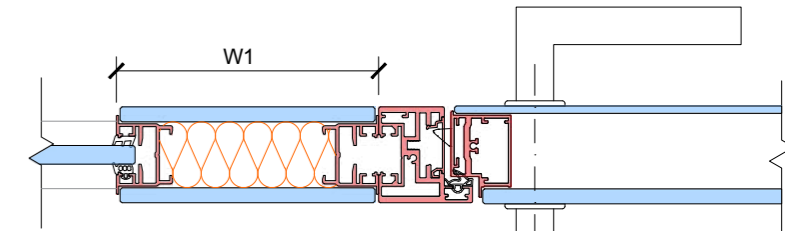

var. 2: IP140 / IP220 design

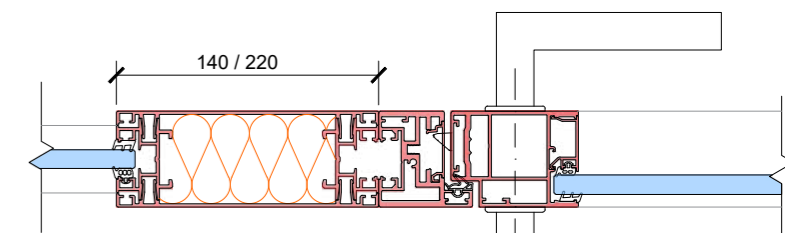

var. 3: IP board

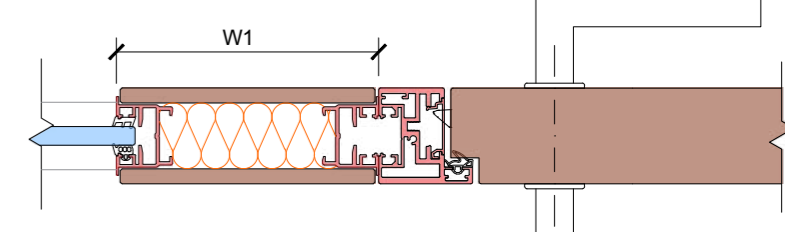

var. 4: IP basic

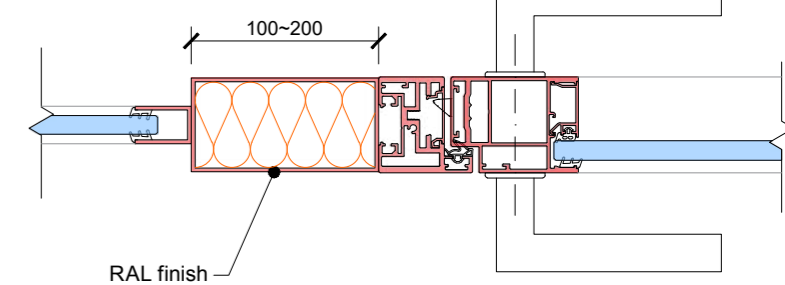

## DEXO Switches and Readers

Our Smart Office solutions include intelligent switches. Choose the one that suits you and customise the functions to your needs. We offer black and white variants, in both glossy and matte finishes.



DEXO Touch  
touch switch



DEXO Touchless  
contactless switch



Touch  
contactless switch



Switch  
switch (suitable for blinds, roller shutters, etc.)



Dimmer  
LED light dimmer



Access  
access via reader

## Types of Walls

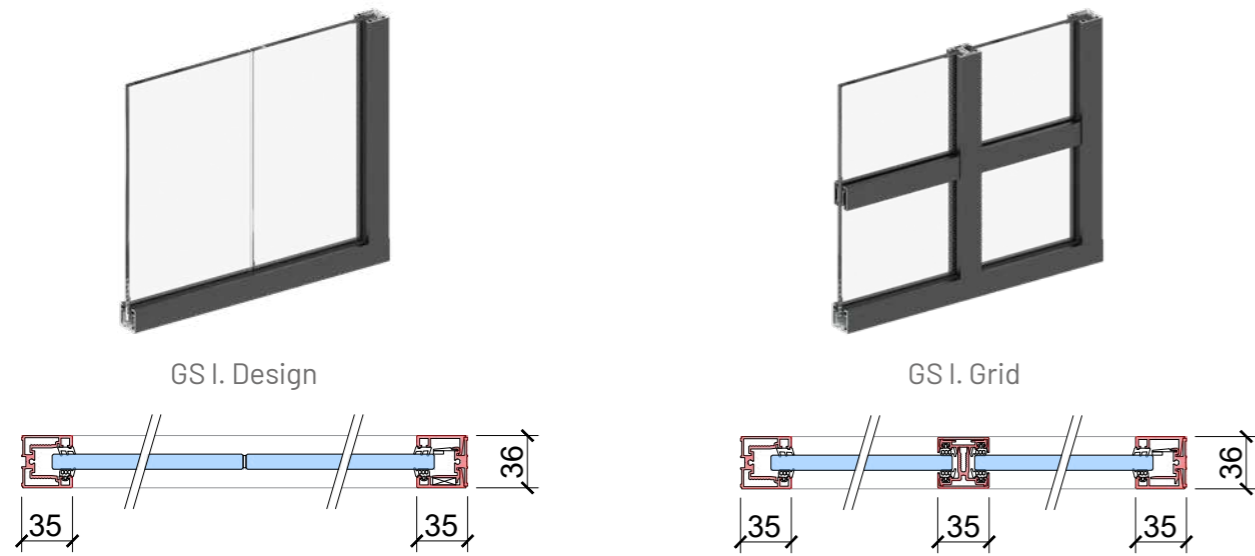

GS I. standard

GS Flamo

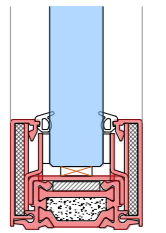
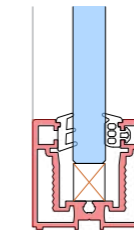

Design

Grid

Flamo



## Types of Doors

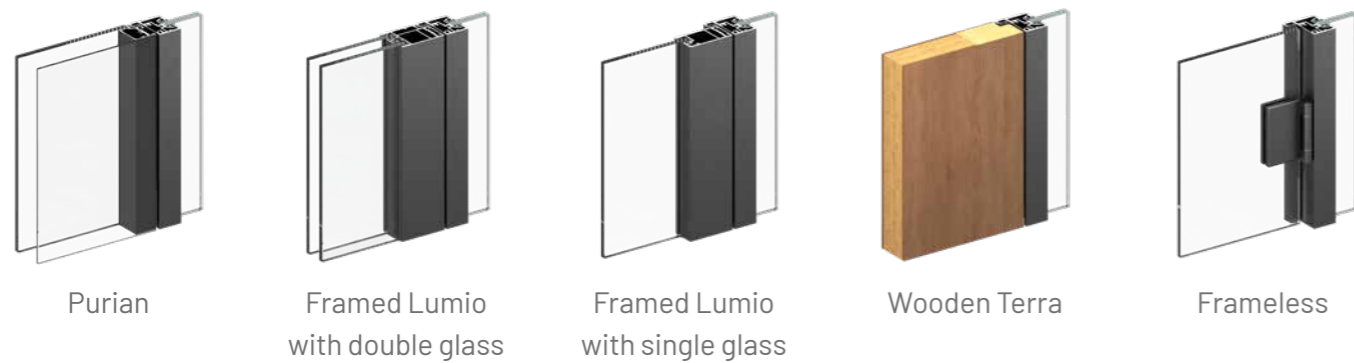

Purian

Framed Lumio  
with double glass

Framed Lumio  
with single glass

Wooden Terra

Frameless

## Horizontal Door Sections

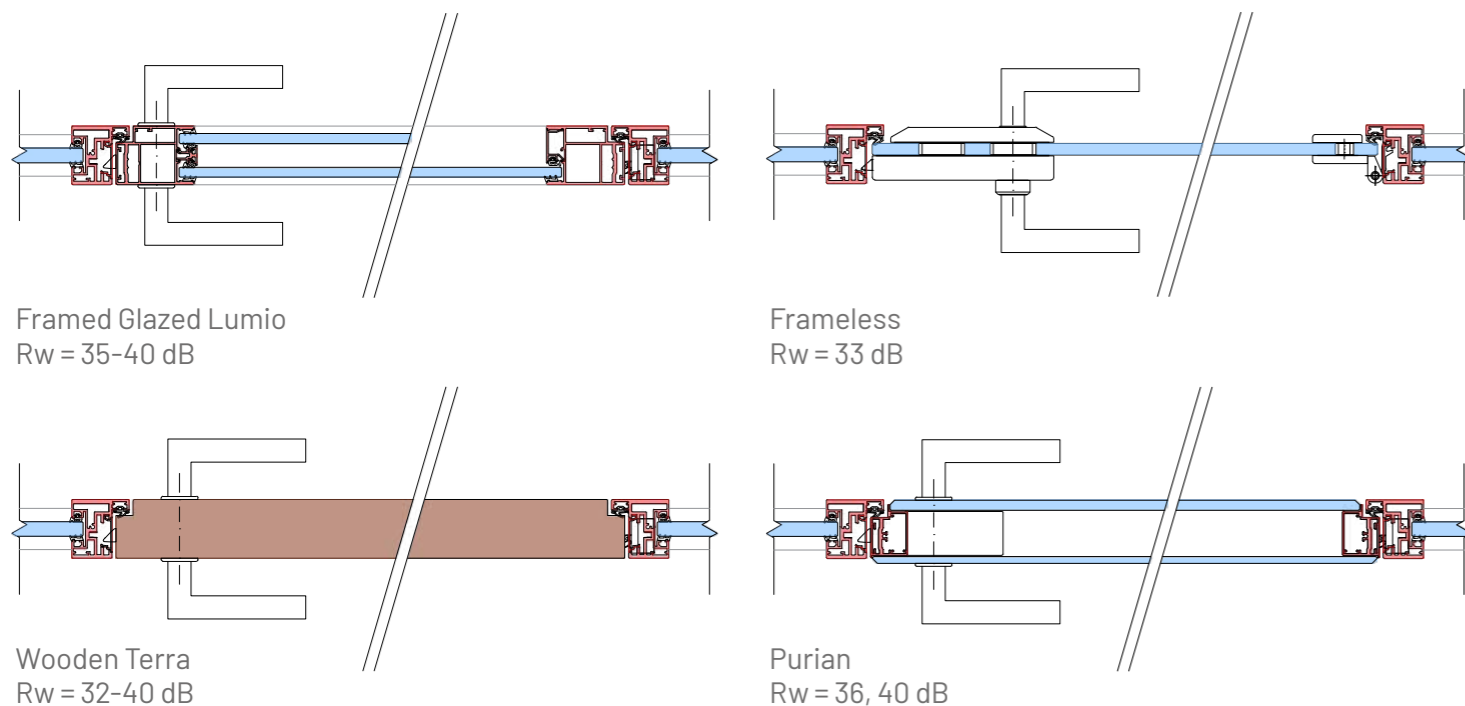

Framed Glazed Lumio  
Rw = 35-40 dB

Frameless  
Rw = 33 dB

Wooden Terra  
Rw = 32-40 dB

Purian  
Rw = 36, 40 dB

Height (mm)	3400*	3400*	4000*
Modular Width (mm)	600-1200	600-1200	≤ 1200
Sound Insulation Rw	33 to 41 dB	36 to 41 dB	38 to 44 dB
Fire Resistance	—	—	EI 15 / EI 30 EI 45 / EI 60
Types of Glazing	ESG 10, 12, VSG 55.x, 66.x, 88.x, 106.2		Pyrobel 16 VSG 66.x
Approval ETA	ETA		
Application	Office buildings, mixed-use buildings, schools, healthcare facilities...		

\* based on the type of glazing used

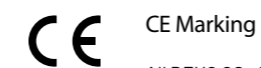

CE Marking

All DEXO GS glazed wall systems have been tested by the Building Research Institute in accordance with the standards ETAG 003 / EAD 210005-00-0505. Based on the European Technical Assessment (ETA), they meet the requirements for CE marking, confirming their quality and compliance with European regulations.



Acoustic Insulation

DEXO GS partition systems were laboratory-tested by the Building Research Institute according to EN ISO 10140-2. The tests confirmed high sound insulation performance that meets demanding acoustic requirements.



Fire Resistance

The DEXO GS Flamo wall system was tested by the Building Research Institute according to EN 1364-1 and achieved fire resistance classifications EI 15, EI 30, and EI 60, depending on the type of glazing used.

PRAGUE - BRNO - OSTRAVA - BRATISLAVA

[www.dexo.cz/en](http://www.dexo.cz/en)

